

ND

NARROW DIAMETER
implant



C-TECH
IMPLANT

TABLE OF CONTENTS

ND - NARROW DIAMETER IMPLANT

Implant characteristics	page 04
Dental implant	page 05
Open Tray Impression Transfer	page 06
Titanium Abutments	page 07
O-Ball Abutments	page 08
Reduced Surgical Kit	page 09
Surgical Procedure	page 09
Surgical kit components	page 10



All of the materials produced by C-TECH follow a validated procedure, which includes surface treatment and packing as well, in conformity with European and international directives EN ISO 13485:2003/AC:207 and 93/42/EEC relative to medical devices.



PRECISION DENTAL SOLUTIONS

C-Tech Implant is a dynamic company with aggressive growth, producing components and product lines primarily for dental implantology.

INTERNATIONAL PRESENCE

With production and management based in Italy, C-Tech Implant is active in all major world markets and is distributed in over 20 countries.

SCIENTIFIC RESEARCH, ADVANCED TECHNOLOGY, SIMPLIFICATION

C-Tech Implant differentiates itself with attention to research and the application of high technology to its products, all while maintaining a simplicity of insertion and ease of use.

C-Tech Implant incorporates the latest trends in implantology but providing for very practical surgical and prosthetic solutions aimed at offering the practitioner and the patient optimal results.

HIGH QUALITY STANDARDS KEPT WITHIN REACH

C-Tech Implant products are made to the highest standards governing the manufacturing and management of European medical and dental components.

Up to date audits and certifications assure that these standards are vigilantly maintained.

TRAINING & ADVICE

Dental professionals are assisted by the rich knowledge and experience of C-Tech Implant personnel and through C-Tech courses and training sessions.

During these courses the professional is able to learn the latest methods of implant placement and reconstruction.

MISSION STATEMENT

The goal of C-Tech Implant is to provide the highest level of quality for technologically advanced products at reasonable prices in order to allow the dental practitioner to find solutions for the broadest range of patients.



ND

NARROW DIAMETER implant

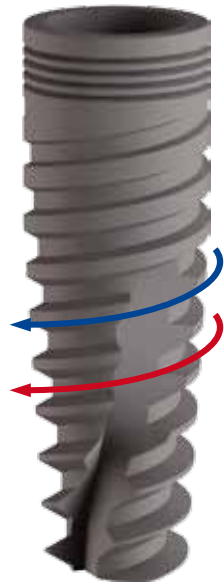

IMPLANT CHARACTERISTICS

INTERNAL HEXAGON CONNECTION

A reliable internal connection ensures a stable prosthetic platform that can carry the loads that will be encountered by the ND implant.

COLLAR MICRO-GROOVING

The specific micro-architecture of the implant collar increases the primary stability and facilitates the introduction of the implant. It promotes the soft tissue healing process and reduces the risk of bone loss at collar level.

MAIN BODY THREADING

Generously dimensioned main body threading provides surface area and stability despite the slenderness of the implant.

APICAL THREADING

The lower part of the implant is endowed with aggressive threads providing better stability and bone engagement.

MATERIAL

The implant is made of medical grade 5 Titanium. The hardest alloy in use for dental implants, further ensuring the strength of this narrow dimensioned implant.



DENTAL IMPLANT

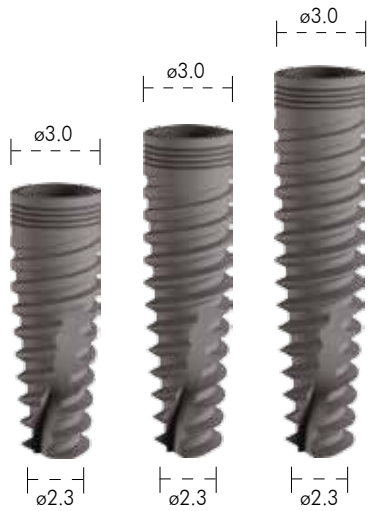

9 mm	ND-3009
11 mm	ND-3011
13 mm	ND-3013

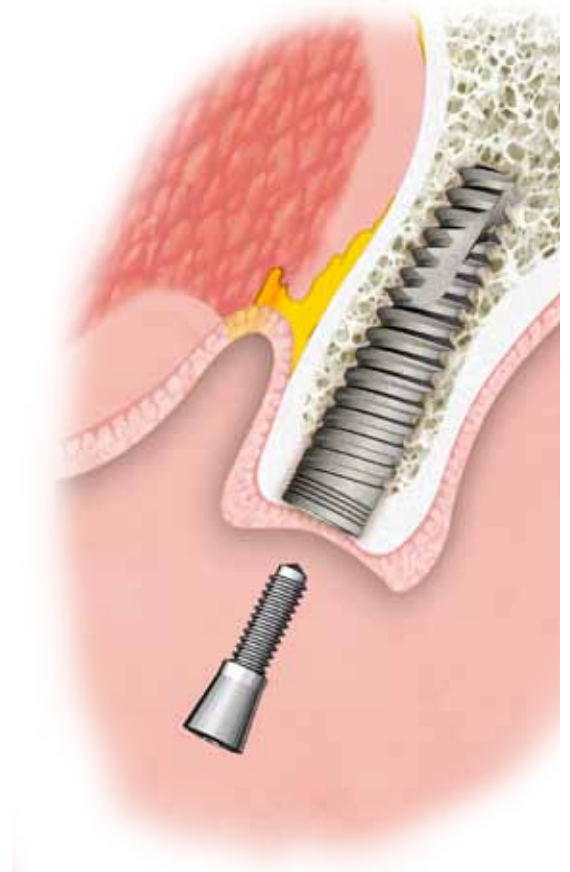

COVER SCREW	HEALING ABUTMENTS			
<p>ND-3008 0.8mm</p>	<p>H2</p> <p>ND-3022</p>	<p>H4</p> <p>ND-3024</p>	<p>H6</p> <p>ND-3026</p>	

PACKAGING

Cover Screw ND-3008 0.8mm

OPEN TRAY IMPRESSION TRANSFER



ND-3040
Open tray Transfer
includes screw



ND-3041
Impression Post Screw



ND-3042
Analog

①



②



③



④



BL-4543
Each pack
contains 2 pcs



COMPLETE SET
- plastic cap - screw - metal transfer
Ref. ND-3040/2

①



②



③



④

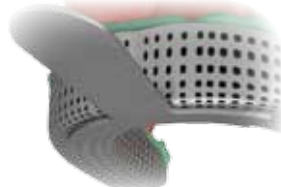

INTENDED USE

Open tray impression technique.

CHARACTERISTICS

- Simple;
- Slender emergence profile accommodates space limitations;
- Guide screw can be tightened either by hand or with the SCS screwdriver;
- High precision impression components give an exact replica of the intraoral situation;
- Clear-cut tactile response from the prosthetic connection verifies proper seating of components.

NOTE

Open tray impression procedure requires a custom-made tray with perforations. Impression posts are intended for single use only to ensure optimal fit and precise impression taking for each patient.

STEP 1

Place the impression post accurately into the implant and hand-tighten the guide screw.

STEP 2

Make perforations in the custom-made impression tray (light cured resin) according to the individual situation so that the positioning screw of the impression post sticks out.

STEP 3

Take the impression using an elastomeric impression material (polyvinyl siloxane or polyether rubber).

STEP 4

Reposition and fix the analog in the impression using the screw.

STEP 1

Place the impression post accurately into the implant and hand-tighten the guide screw.

STEP 2

Push the impression cap at the top of the impression transfer.

STEP 3

Take the impression using an elastomeric impression material (polyvinyl siloxane or polyether rubber).

STEP 4

Use a standard impression tray.

TITANIUM ABUTMENTS

TITANIUM Ø 4 STRAIGHT ABUTMENTS

INCLUDES SCREW

ND-3025-1 ND-3025-2 ND-3025-3

TITANIUM 15° ANGLED ABUTMENT

INCLUDES SCREW

ND-1530

ABUTMENT SCREW

ND-5052HX

CASTABLE ABUTMENT

ND-5830

INTENDED USE

Cement-retained restorations.

CHARACTERISTICS

- Simple;
- Less grinding necessary due to prepared mucosa margins;
- Adaptation to natural soft tissue contour due to prepared mucosa margins in different heights (H1, H2, H3);
- Oval shape resembles emergence profile of a natural tooth
- Reliable;
- Tapered connection (pure cone). Abutment and implant are linked so as to form a one-piece unit;
- Extractor system allows easy abutment removal from the implant or the analog.

NOTE

The cement margin must not be more than 2 mm below the mucosa. Use a new basal screw for the final insertion of the abutment.

STEP 1

Placement of the abutment in the model analog.

STEP 2

Preparing the titanium abutment, modifying as required.

STEP 3

Creation of the restoration.

STEP 4

Cast the framework using the standard casting methods.

STEP 5

Veneer the superstructure.

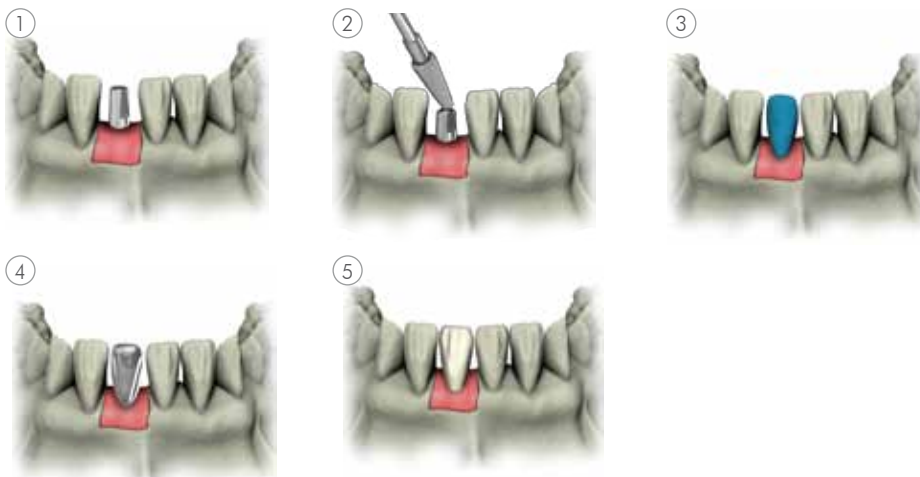

O-BALL ABUTMENTS

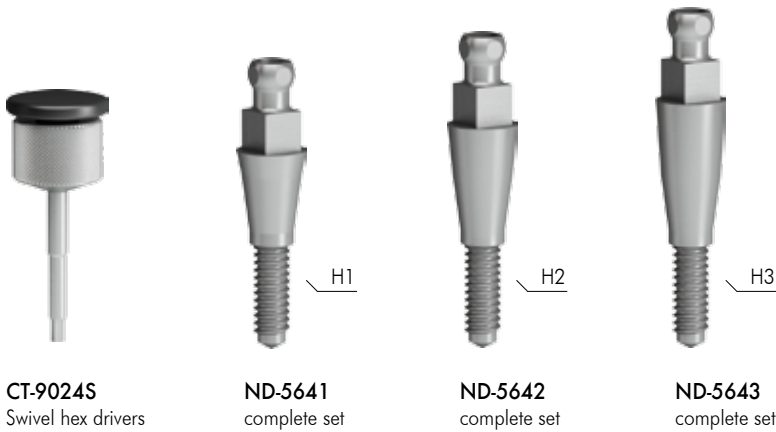

METAL HOUSING



MCH-1
Soft Retention



MCH-2
Medium Retention



MCH-3
Hard Retention



MC-3005B
O-ring (5 pieces)



MC-3005
O-ring (5 pieces)

LABORATORY ACCESSORIES



MC-3013
Temp Cap



MC-3014
Transfer Cap



MC-3007
Collared Analog

①



②



INTENDED USE

Removable dentures retained by implants in the mandible and maxilla.

CHARACTERISTICS

- Simple;
- The clinical process for the ball attachment is quick and easy;
- Functional;
- The O-ring attachment is designed to virtually eliminate wear on the Ball Abutment and minimize the need for maintenance;
- 3 different gingival heights;
- 3 different O-ring resistances offering optimal retention for every individual situation.

RELIABLE

Dual retention for optimal abutment-denture connection. Excellent long-term performance due to wear resistant components.

STEP 1

Screw the spherical abutment into the implant using the torque ratchet (30 Ncm) and the driver (ref. CT-9024S).

STEP 2

Rebase the overdenture according to the standard procedure.

COMPLETE SET INCLUDES:



1. O-Ring (Ref. MC-3005, MC-3005B)
1 piece
2. Metal Housing (Ref. MCH-2)
3. O-Ball Abutment (Ref. 5644, 5642, 5641)

REDUCED SURGICAL KIT

REDUCED SURGICAL KIT INCLUDES:

Locator drill CT-2020
 2.0 external irrigation drill (Ø 2.0) CT-1720E
 2.6 external irrigation drill (Ø 2.6) 00075CUT
 Stopper (9mm) CT-stop07
 Stopper (11 mm) CT-stop-08
 Stopper (13 mm) CT-stop09
 Drill extender ct-2000
 1.25 swivel hex driver short CT-9024s
 1.25 swivel hex driver long CT-9024
 Implant ratchet driver short ND-E7001
 Implant ratchet driver long ND-E70011
 Torque wrench (50 Ncm) CT-8010
 Paralleling pins qty 2 (1.6 mm- 2.0 mm) CT-9000
 Depth Gauge (3.5 mm) CT-E9007
 Depth Gauge (4.3 mm) CT-E9007



REFERENCES:

ND Sur.Kit.02
 Reduced kit for Narrow platform line

SURGICAL PROCEDURE

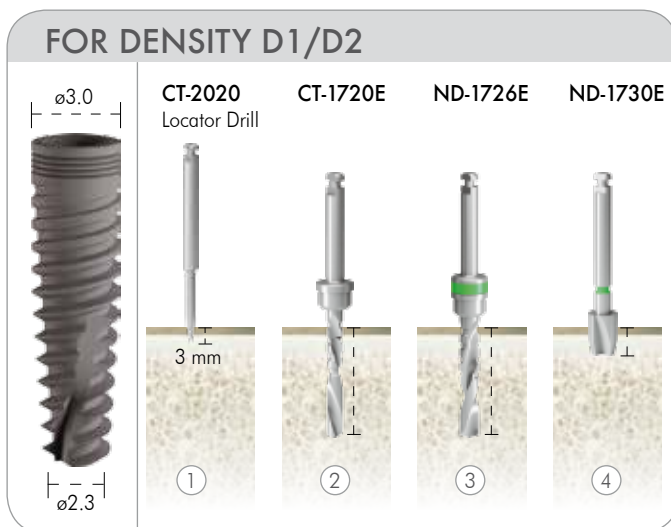

STEP 1: Perforate the cortical plate with the locator drill (CT-2020)
 STEP 2: Drill whole length of implant with 2 mm drill (CT-1720E)
 STEP 3: Drill whole length of implant with 2,6 mm drill (ND-1726E)
 STEP 4: In case of very compact bone: use 3 mm counterbore for 2 mm depth (ND-1730E)

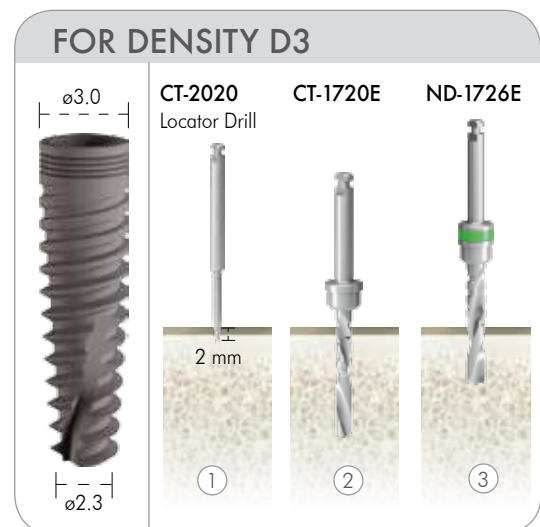

STEP 1: Perforate the cortical plate with the locator drill (CT-2020)
 STEP 2: Drill whole length of implant with 2 mm drill (CT-1720E)
 STEP 3: Drill 1/3 length of implant with 2,6 mm drill (ND-1726E)

SURGICAL KIT COMPONENTS

SURGICAL FACILITATORS

PARALLELING PINS



CT-9003
3.5 mm
4.3mm



CT-9000
1.6 mm
2.0mm



CT-2000
Drill Extender

DRILL DEPTH STOPS



CT-STOP07
Stop L.9



CT-STOP08
Stop L.11



CT-STOP09
Stop L.13

PROSTHETICS DRIVER



CT-9025S
Hex drivers



CT-9025
Hex drivers



CT-9019
Handpiece Latch



CT-9024S
Swivel hex drivers



CT-9024
Swivel hex drivers



CT-8051
Torque wrench
attachments



CT-8052
Torque wrench
attachments

ND IMPLANT DRIVERS



ND-E7001
Implant ratchet
driver



ND-E7001L
Implant ratchet
driver



ND-E9040
Implant latch
driver

TORQUE WRENCH 50Ncm



CT-8010





Via Santa Margherita al Colle n. 18 - 40136, Bologna - ITALY - Tel. +39 051.81.49.14
www.c-tech-implant.com - info@c-tech-implant.com